



## KTX-NS01EU - Quick Start Guide -



---

### **ALPS ALPINE NORTH AMERICA, INC.**

1500 Atlantic Blvd,  
Auburn Hills, Michigan 48326, U.S.A.  
Phone 1-800-ALPINE-1 (1-800-257-4631)

### **ALPINE ELECTRONICS OF AUSTRALIA PTY. LIMITED**

161-165 Princes Highway,  
Hallam Victoria 3803, Australia  
Phone 03-8787-1200

### **ALPS ALPINE EUROPE GmbH**

Ohmstrasse 4, 85716 Unterschleissheim, Germany  
Phone: +49 (0) 89-32 42 640

For contact information on your respective country,  
please visit [www.alpine-europe.com](http://www.alpine-europe.com).

### **ALPS ALPINE EUROPE GmbH**

Aurora House, Deltic Avenue  
Rooksley, Milton Keynes, MK13 8LW  
United Kingdom  
Phone: 0345-313-1640

### **ALPS ALPINE ASIA CO., LTD.**

The 9th Towers, Tower B, 24th Floor, Unit TNB01-03,  
33/4 Rama 9 road, Huay Kwang, Bangkok, 10310, Thailand  
Phone +66 (2) 090 9596

## CONTENTS

Connection Guide	2
Compatible Models	3
Software Version	3
Time Setting	4
Permission Setting	5

## Connection Guide

### Getting Started

For correct operation; please follow the connection procedure for Alpine Navistick. The included 10cm USB converter lead must be used for correct operation.

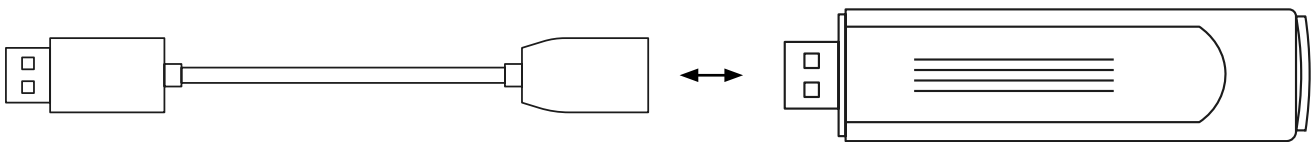

Once Navistick is connected to the included USB converter lead, you can connect the device to the USB port of your compatible Alpine headunit.

## Compatible Models

### Operation Guide

The following models are compatible with Navistick; iLX-507A, iLX-F509A, iLX-F511A and i905 models (i905-LC70, i905-LC08 and i905-LC16). Maestro and non-Maestro units are compatible. To use Navistick; Connect the device to the grey or black USB port.

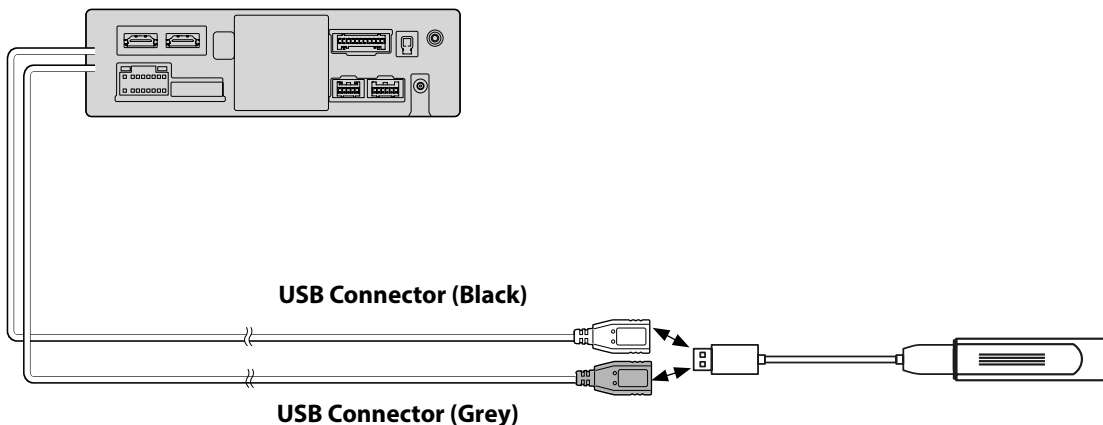

# Software Version

## Headunit Software Version

To check the software version on your Alpine headunit, follow the steps below.

1. From the home screen, press **Setup**



2. In the Setup menu, press **System** then press **About**

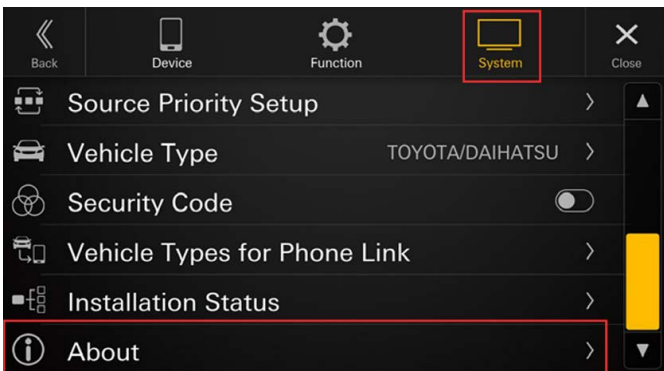

3. In the About menu, check the firmware version is 5.00.00 or above.

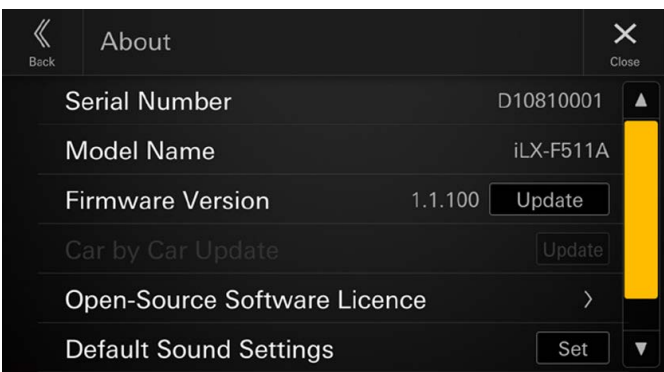

## Important Notice

**Your Headunit must be above Firmware Version 5.00.00 for compatibility with Navistick.**

If your unit is below Firmware Version 5.00.00, please visit the Alpine website or your local Alpine Authorised Dealer to perform the software update.

# Software Version

## Navistick Software Version

To check the software version on your Navistick, follow the steps below.

### 1. From the Hema Navigation Home screen > Press Settings

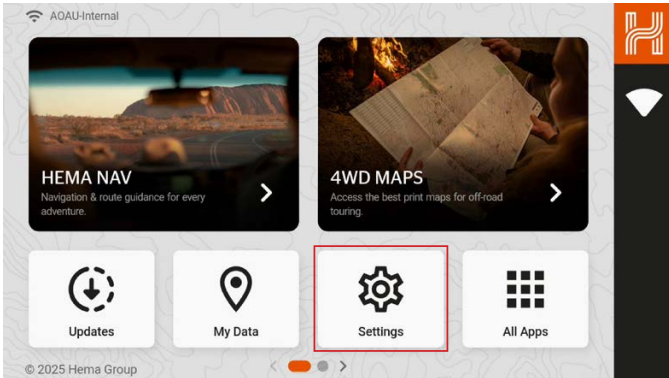

### 2. In the Hema Settings Menu > Press Device

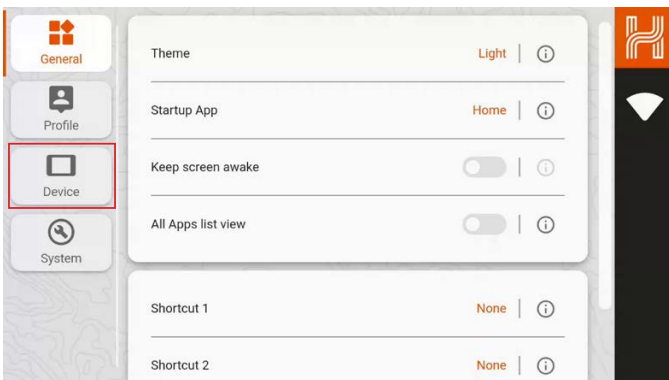

### 3. In the Device Menu > Check the Build version is 2.5.26

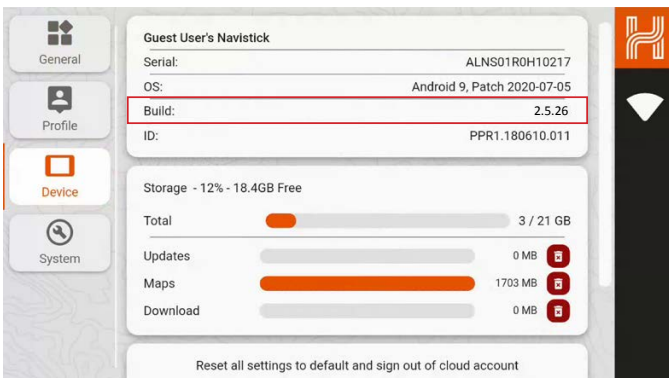

## Important Notice

**If your Navistick Build Version is 2.5.24 > Contact your local Alpine Authorised Dealer**

Your unit will need to be updated, this is a technical procedure and will need to be returned to your local Alpine Authorised Dealer for a system update.

# Time Settings

## Updating Time / Language

Follow the steps below to update the Time or Language on your Navistick.

1. From the Hema Navigation Home screen > Press **Settings**

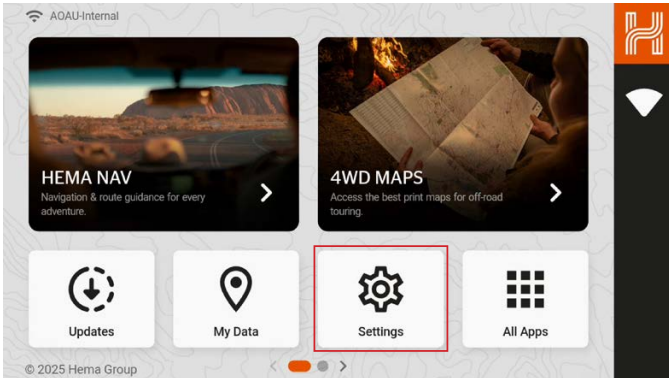

1. From the General Settings Menu > Press **System**

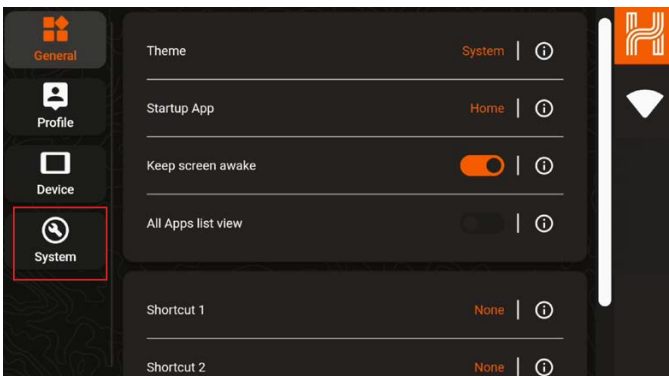

1. You can access and change **Date & Time** Settings or **Language** Settings

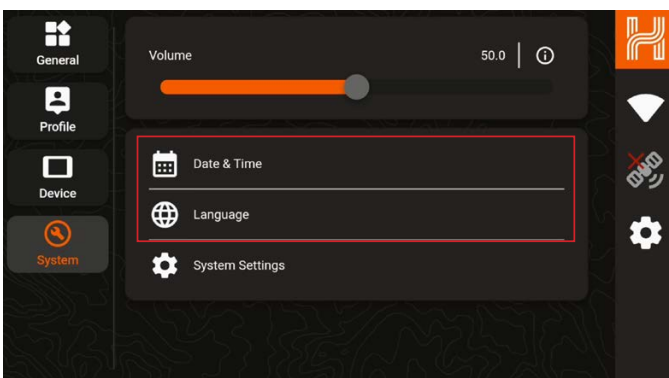

## Date & Time/Language Notice

Your Navistick language comes preset as English (Australia). If your language is set to English (UK), you will need to add the English (Australia) language and remove the English (UK) language to add Australian Time Zones.

# Permission Settings

## Updating Permission Settings

If the Hema Navigation application will not launch, please confirm permissions are enabled following the steps below.

1. From the Hema Home screen > Press Settings. In the Settings Menu > Press Device

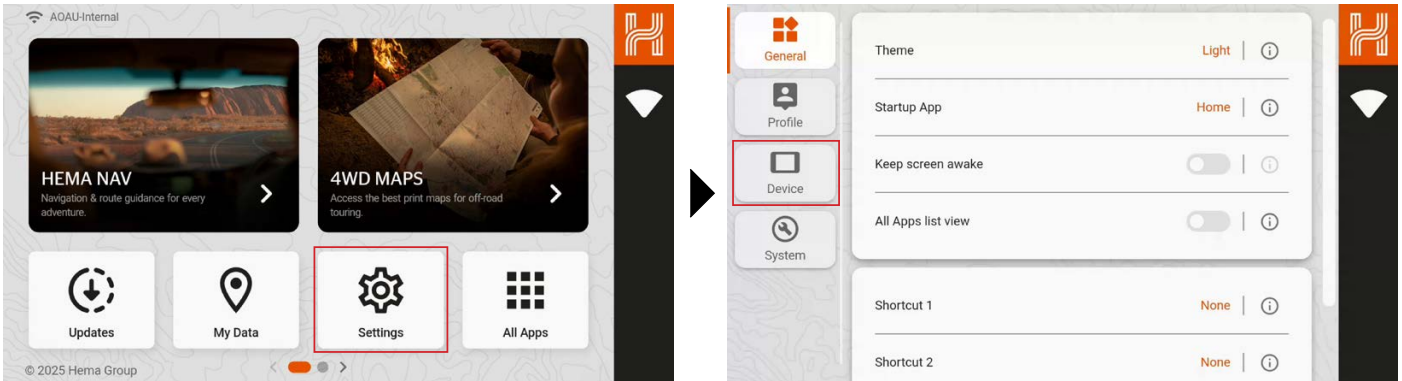

2. In the Device Menu > Press Storage. Scroll down > press Other apps

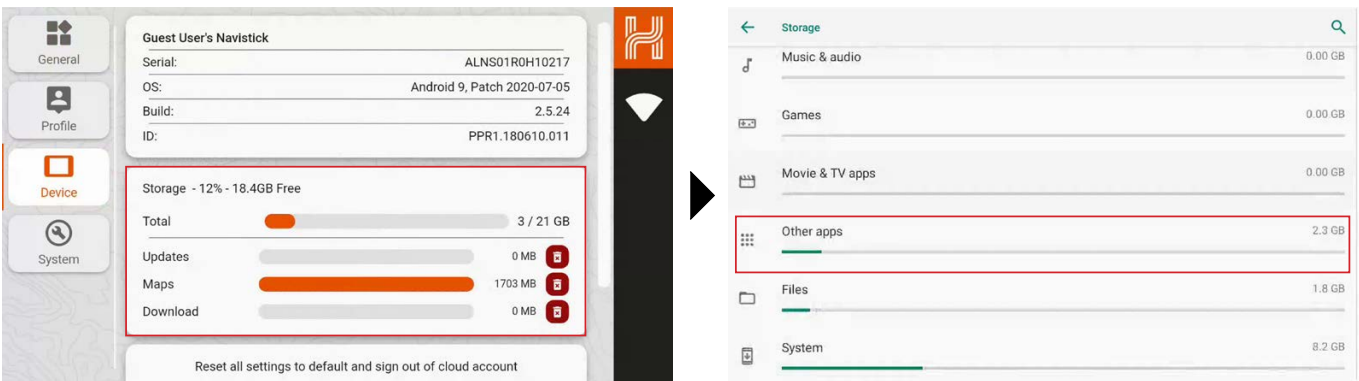

3. Press Hema Maps Navigation > Then, Press the Hema Maps Navigation Icon

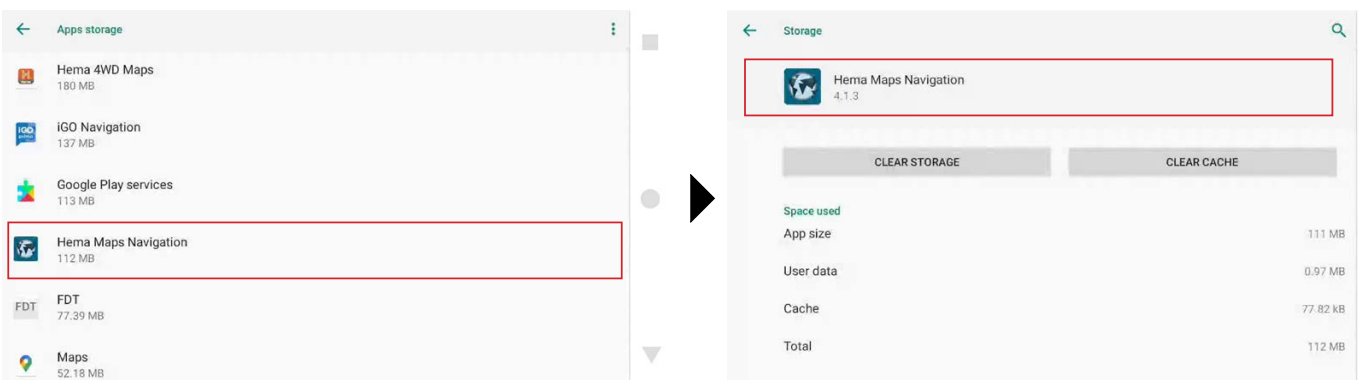

# Permission Settings

## Updating Permission Settings

### 4. Press & Enter the Permissions Menu > Toggle all Permissions to ON

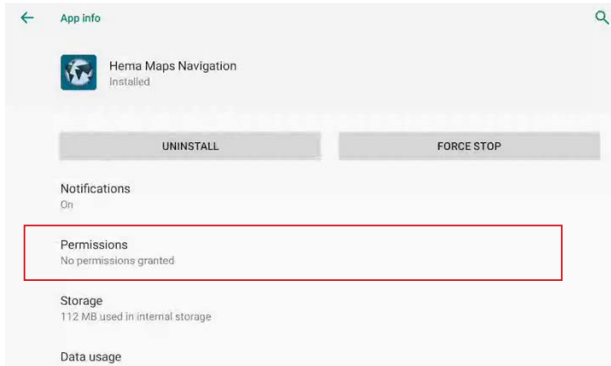

### 5. Exit the Permissions Menu > Press the square icon to proceed

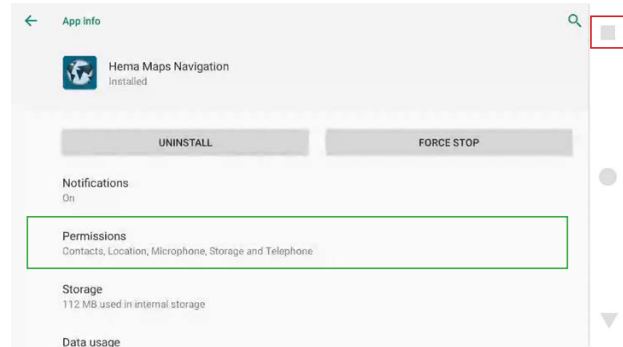

### 5. Swipe up and return to Hema Navigation > Hema Maps is now ready for use

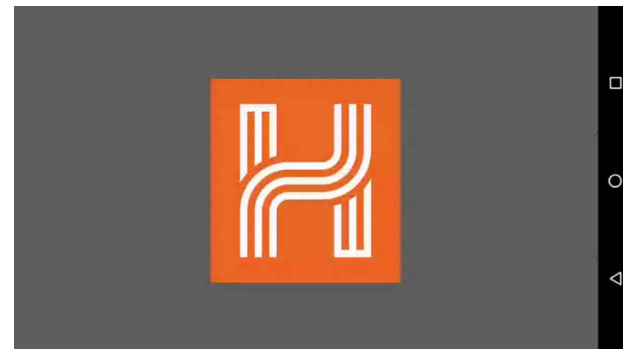
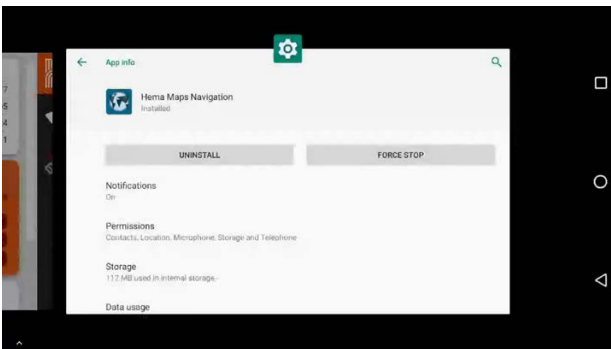



[Getting Started with Hema Nav & 4WD Maps >](#)

Scan the QR code to learn about Hema Nav & 4WD Maps



For more information visit [www.alpine.com.au](http://www.alpine.com.au)